

ERA PROTECT

Smart Universal Door Handle
USER GUIDE

FOR
OPERATION

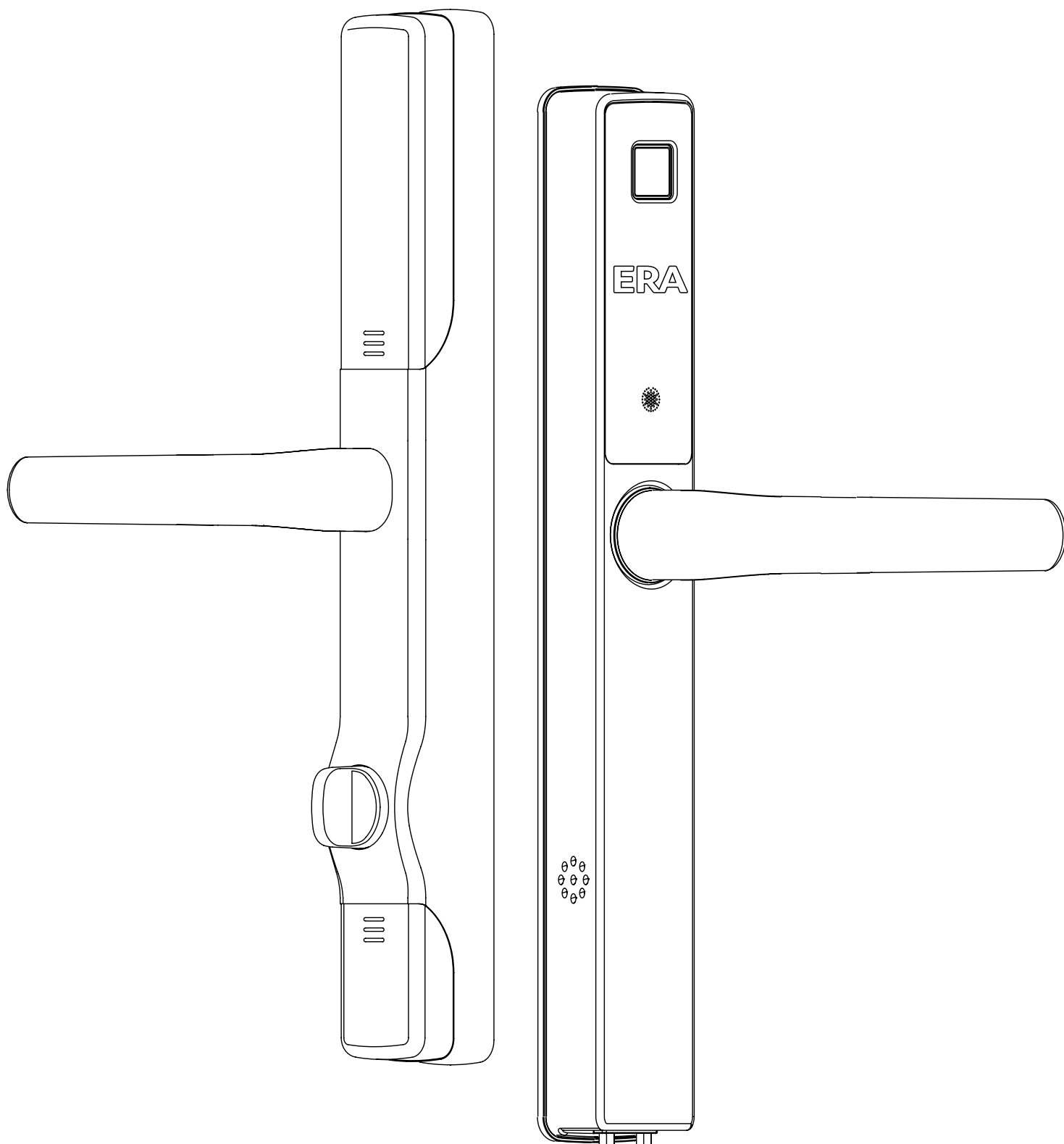

Model number: DHAEP1
V1



Welcome to **ERA Smart Home** a complete ecosystem for home security.

Visit **eraprotect.com** to find out how to combine your **Smart Universal Door Handle** with ERA's series of smart security devices. Including a smart alarm system, video doorbell, and cameras.

Here if you need us

Your ERA product is designed to be up and running in minutes, but if you do need help there are lots of handy videos and information available on our website, or contact us for further assistance or support.

Visit **eraprotect.com**
or call us **0345 646 1487**

!
IMPORTANT

Please ensure you read the installation instructions thoroughly before installing. The instructions must be followed in sequence.

Smart Universal Door Handle

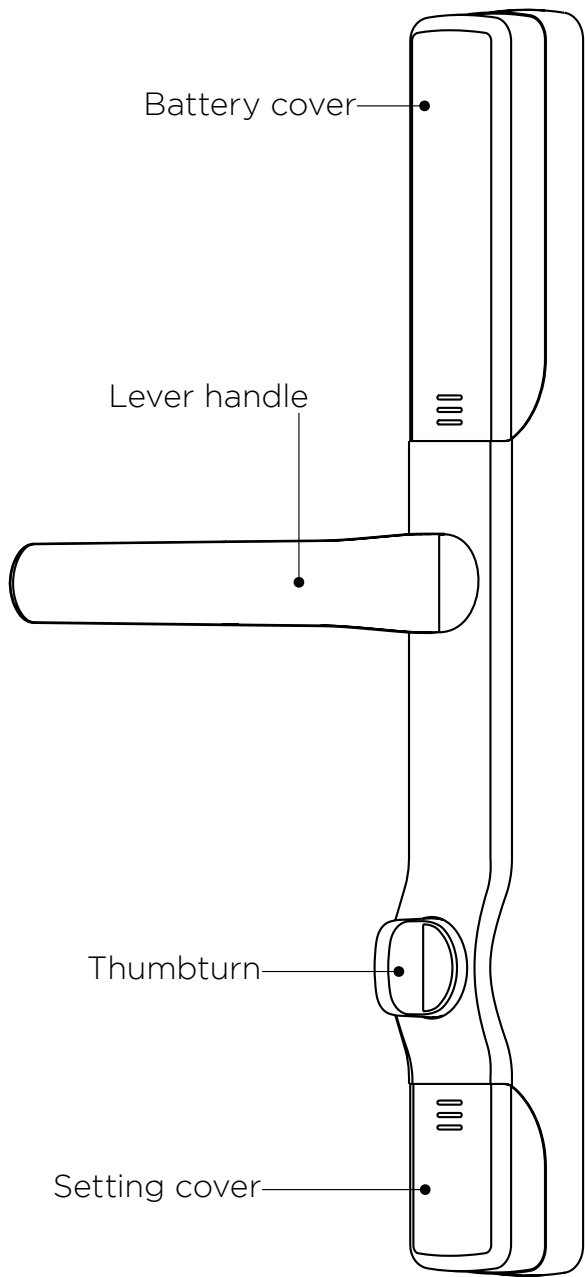

INSIDE

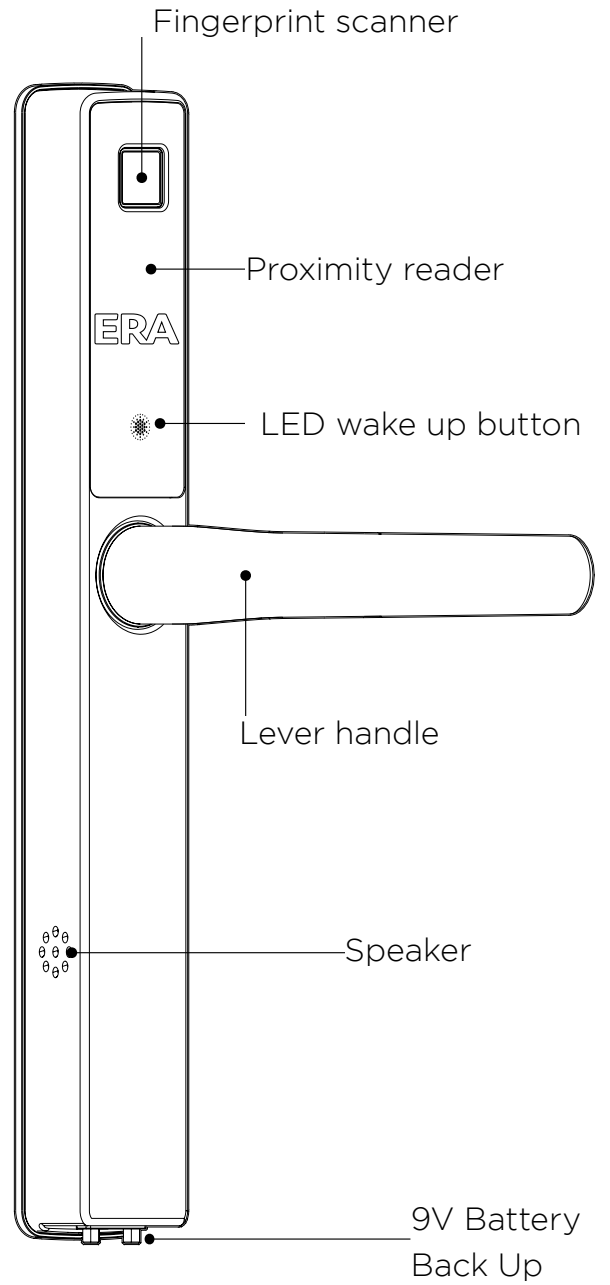

OUTSIDE

Contents

- 5 Creating an account and adding your Smart Universal Door Handle
- 7 Adding your Smart Universal Door Handle to an existing ERA Smart Home account
- 8 Adding an ERA WiFi Connection Hub from the settings
- 9 Adding a fingerprint
- 11 Using the 'set' button to add a fingerprint
- 12 Deleting a fingerprint
- 13 Adding a key card
- 14 Using the 'set' button to add a key card
- 15 Deleting a key card
- 16 Unlocking your handle via the app
- 17 Enable and disable Geolocation
- 18 Automatically unlocking your Handle with Geolocation via Bluetooth
- 19 Unlocking your handle via the thumbturn
- 20 Deadlocking and auto locking your handle
- 21 Creating administrator, guest and family
- 22 Logging in as a guest / family user and changing passwords
- 23 Account access and user permissions
- 24 Enabling and disabling audio
- 25 Renaming your handle
- 26 Back Up Power
- 27 Deleting your handle
- 28 How to factory reset your handle
- 29 Decommissioning your device
- 30 Deleting an ERA account
- 30 Understanding your Smart Universal Door Handle
- 31 Warranty information
- 32 Privacy policy
- 33 Things to remember

Creating an account and adding your Smart Universal Door Handle

1



Download the **ERA Smart Home app** (iOS and Android). Turn on your Bluetooth.

Please ensure you download ERA Smart Home app not the ERA Protect app.

2

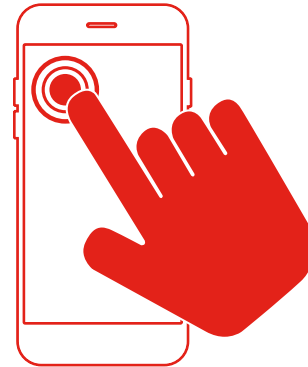

Open the app and create an account by completing the required details. Please review and agree to the terms of service.

3



A verification code will be sent to your registered email account. Enter the code when prompted.

4



On the next screen select "ERA Protect EP1".

5

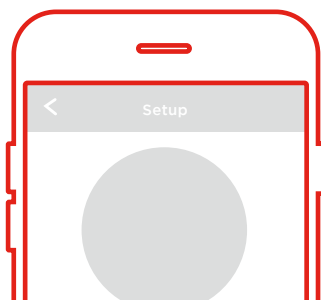

Stand within 2m of your handle and ensure the batteries have been inserted. Press "Continue".

6

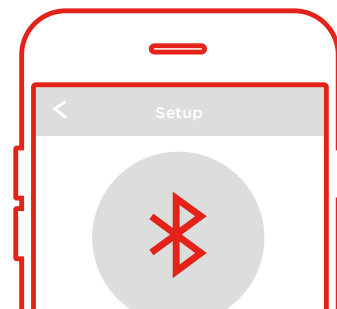

Turn on Bluetooth or if Bluetooth is already enabled please press "Continue".

Creating an account and adding your Smart Universal Door Handle (continued)

7

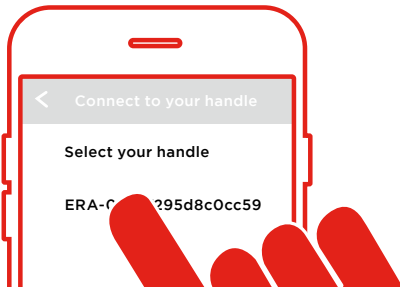

Select your ERA Protect EPI device.

8

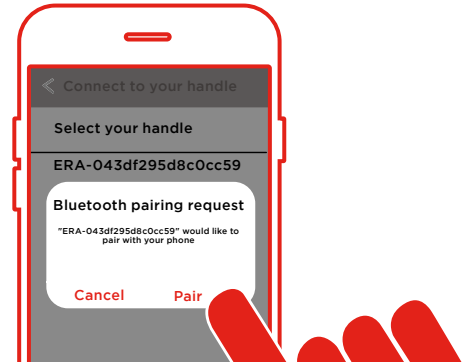

You will receive a "Bluetooth Pairing Request". Click "Pair" to initiate.

9

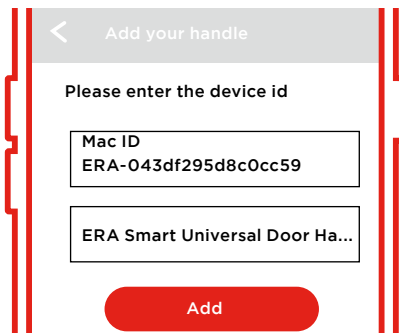

Once connected, enter a name for your handle (for example 'front door') and press "Add". This will now become the name of your handle for your account.

10

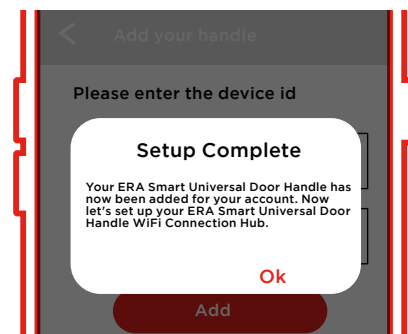

You will see a notification that your account has been created and the ERA Protect EPI device has been successfully added.

At this point you can also set up and add the ERA WiFi Connection Hub see page 8.

Adding your Smart Universal Door Handle to an existing ERA Smart Home account

1



Turn on Bluetooth in your phone settings.

2



Open the ERA Smart Home App (iOS or Android).

3



Select ERA Protect EP1 from the menu and press "Add".

4

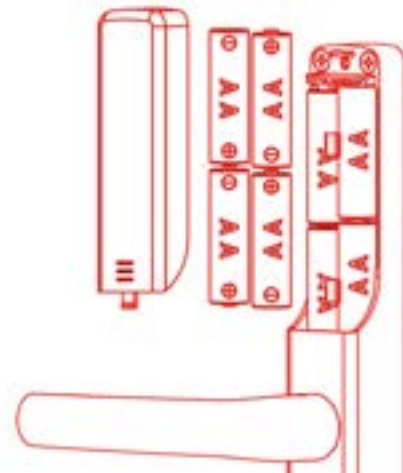

Insert your batteries into your Smart Universal Door Handle

5

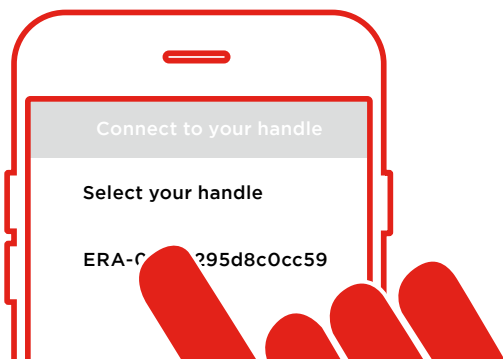

Select your ERA Protect EP1 device.

6

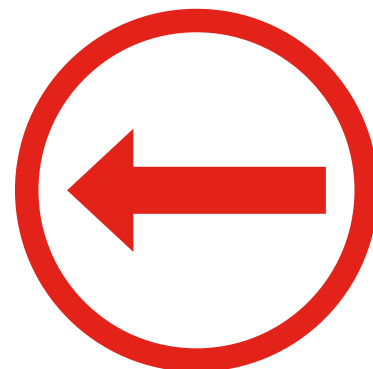

Follow steps 8 to 10 from the previous page.

Adding an ERA WiFi Connection Hub from the settings

1

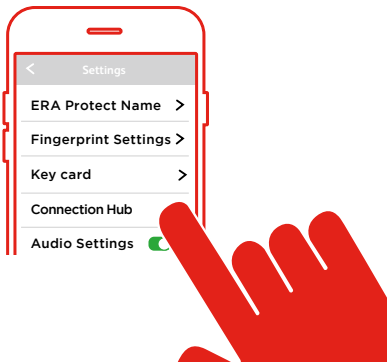

Open settings in the ERA Smart Home app and press "Connection Hub" This will allow you to connect an ERA Connection Hub device to your handle.

2

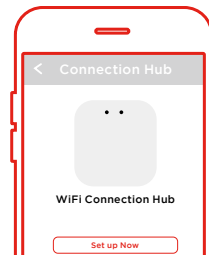

Press "Set up Now" and follow the on screen instructions.

3

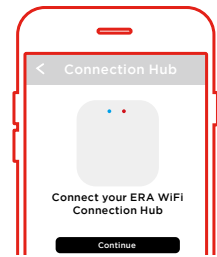

Please ensure your Connection Hub is plugged into a power source and wait for a flashing blue light and then a flashing red light. Press "Continue", the Hub will now start scanning for your EP1 handle.

4

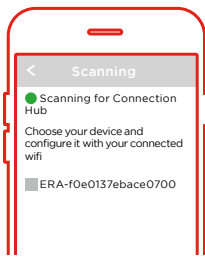

When you see your handle name, select and then select your WiFi network from the list. You will need to enter your WiFi network password, then press "Ok".

5

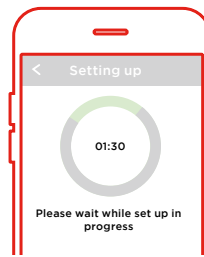

A timer will display once you have connected to your WiFi. This will indicate how long is needed to connect the Hub to your handle. Keep the app open and do not close the screen. If you do, repeat the instructions from step 1.

6



Once set up is complete, read the notification onscreen and select "Start Pairing".

7

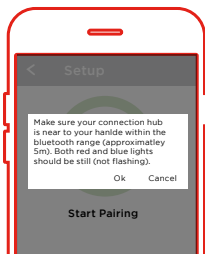

The hub now needs to connect to your handle. Stand within 5m of the handle and then press "Ok".

8

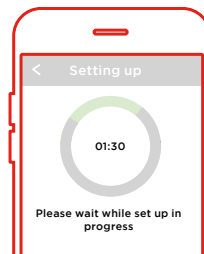

A timer will display again to complete the setup of ERA Connection Hub and your ERA Protect handle.

9

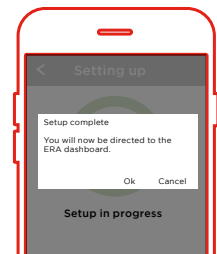

Once set up is complete you will see a pop up notification, please press "OK". Your handle is now connected to both your ERA Protect Handle and Hub.

Adding a fingerprint

1

You may be asked to do this once you have added your handle to your account.



Open the ERA Smart Home app (iOS and Android).

2



Select ERA Protect EP1.

3

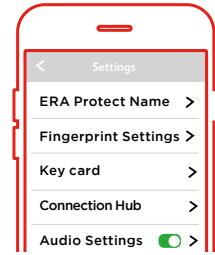

Open settings of your ERA Protect handle.

4

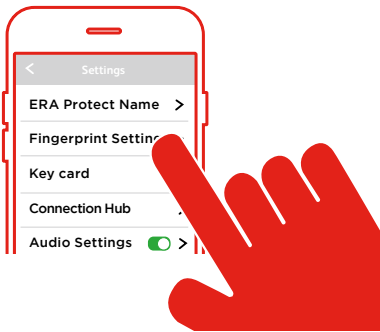

Select "Fingerprint Settings".

5



Click on the "+" to add a print and then name your new print (useful for multiple households).

6

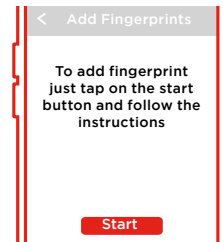

Press "Start" and follow the on screen instructions.

7

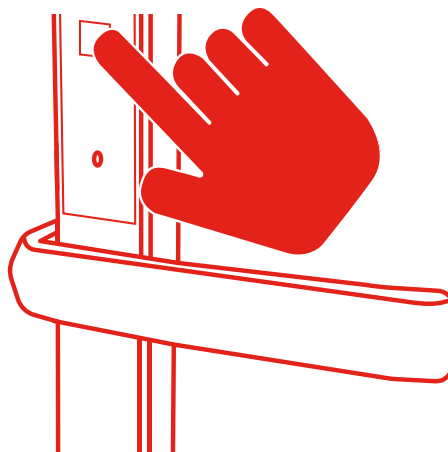

Using your chosen fingerprint (finger / thumb), place over the black sensor on the front of the external handle.

Adding a fingerprint (continued)

8



Follow the on screen instructions and voice prompts. Hold your print centrally into the sensor with firm pressure as you move through the 3 fingerprint screens.

9



Once complete, your print should have been successfully added to the ERA Protect handle

10

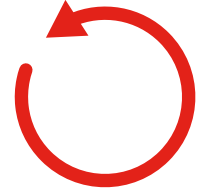

If you experience any issues adding a print the app will return to the beginning, where you can repeat the process.

11

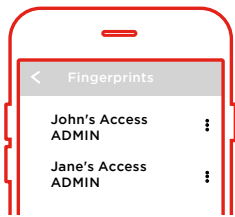

Once the print is added to the handle it will be listed in the fingerprints section.

12

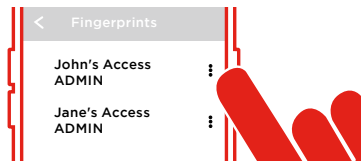

To name, edit or remove a print, press the three small dots to the right of the relevant print.

13



Test a print works by closing the app and placing the stored print on the ERA Protect handle. You will hear "door open" (if voice is enabled) and you can push the handle down to unlock.

14



To additional prints and users repeat the above steps.

15

After 5 consecutive failed unlock attempts using a key card or fingerprint, you will hear "Usage limit exceed. Try again later." and your lock will enter lockdown mode for 1 minute.

During lockdown mode, the key card and fingerprint scanner will be inoperative, however, the handle can still be unlocked using the app.

After 1 minute, the lockdown period is complete and all entry methods are now useable.

Using the 'set' button to add a fingerprint

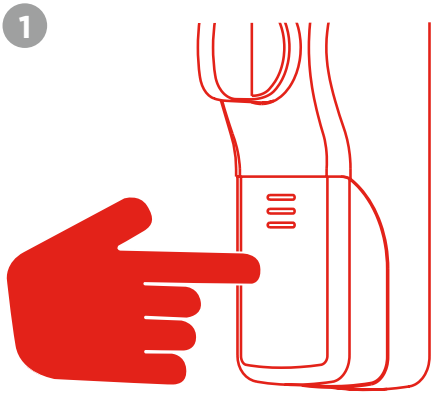

Please turn on the voice prompt if it isn't activated (page xx). Remove the "Set" cover near the base of the external handle using the Allen key provided.

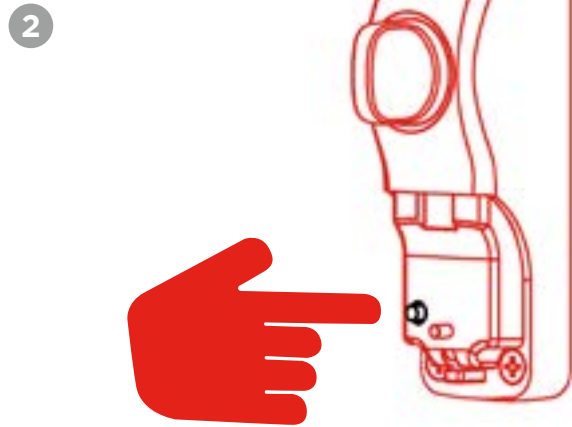

Press the larger button to begin adding a fingerprint.



Follow the steps provided by the "voice prompt". Once complete, please test to see if the added print can successfully open the door. Close the app and place the stored print on the ERA Protect handle. You will hear "door open" (if voice is enabled) and you can push the handle down to unlock.

Deleting a fingerprint

1



Open the ERA Smart Home app (iOS and Android).

2



Select ERA Protect EP1.

3

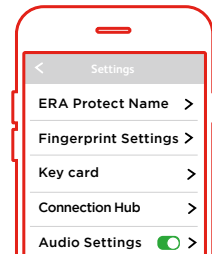

Open settings of your ERA Protect handle. Select "Fingerprint Settings".

3

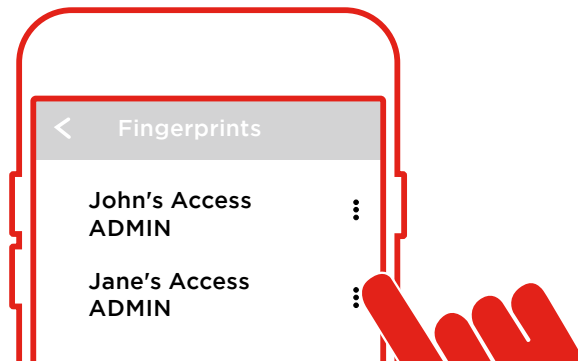

You will see a list of registered prints for the device. Next to each print are three dots, press the three dots next to the print you'd like to delete and press "Delete". Your selected print has now been deleted.

Adding a key card

1



Open the ERA Smart Home app (iOS and Android). Select ERA Protect EP1.

2

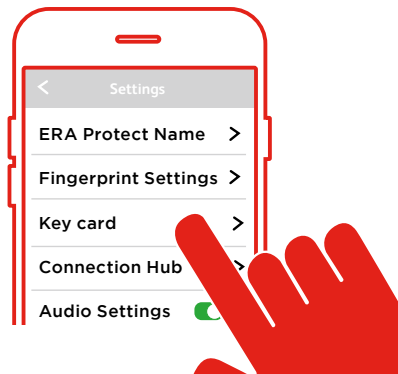

Open settings and press "Key card".

3

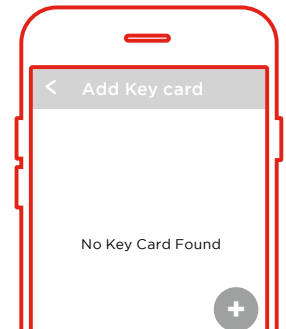

If you have no existing key cards set up, you will see a "No Key Card Found" message. Please press the "+" button to add a key card to your handle.

4



Please name your Key card and press "Add".

5

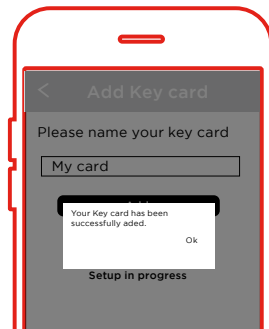

Follow the voice prompts or onscreen instructions. Touch the key card you wish to add to the logo area on the handle. A success notification will display once set up is complete.

6

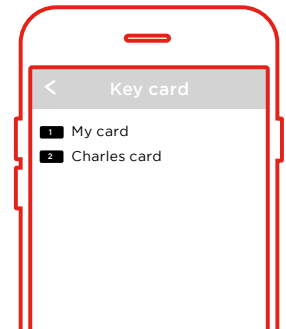

You can now see your named key card in the key card section.

7



Test the key card works by closing the app and touching the 'LED Wake Up' button on the external handle. Place the key card onto the logo area to scan. You will hear "door open" (if audio is enabled) and you can push the handle down to unlock.

8

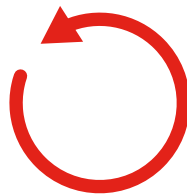

Repeat steps 3 till 7 to add additional key cards.

9

After 5 consecutive failed unlock attempts using a key card or fingerprint, you will hear "Usage limit exceed. Try again later." and your lock will enter lockdown mode for 1 minute.

During lockdown mode, the key card and fingerprint scanner will be inoperative, however, the handle can still be unlocked using the app. After 1 minute, the lockdown period is complete and all entry methods are now useable.

Using the 'set' button to add a key card

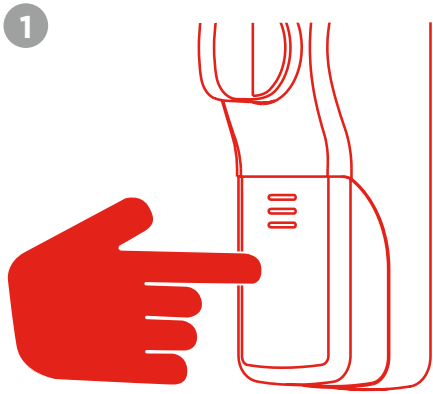

Please turn on the voice prompt if it isn't activated (page xx). Remove the "Set" cover near the base of the external handle using the Allen key provided.

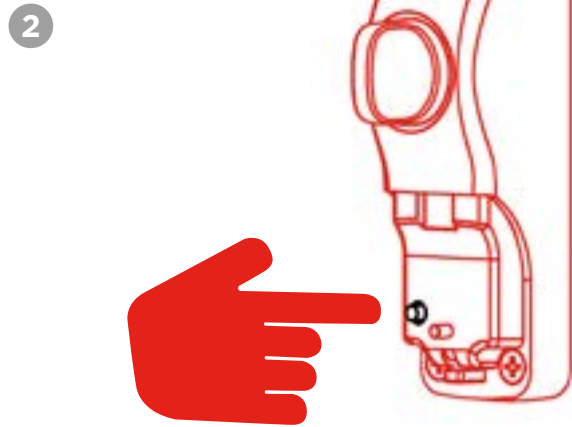

Press the larger button to begin adding a key card.



Follow the steps provided by the "voice prompt" and touch the key card you wish to add to the logo area on the handle. Once complete, please test to see if the added key card can successfully open the door. Close the app and place the key card onto the logo area to scan. You will hear "door open" (if audio is enabled) and you can push the handle down to unlock.

Deleting a key card

1



Follow steps 1 and 2 on the previous page.

2

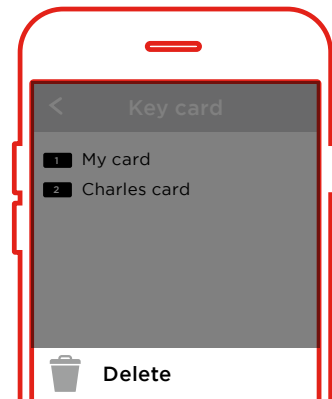

Press on the key card you would like to remove. Press "Delete" at the bottom of the screen.

3

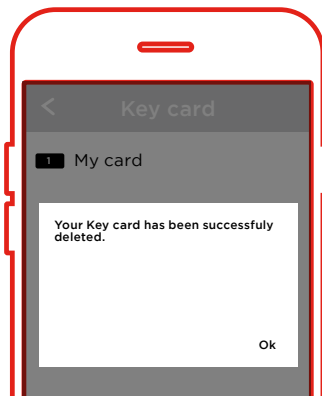

Confirm if you wish to delete this key card by pressing "Ok". Your chosen key card has now been deleted.

Unlocking your handle by using the app

1



Open the ERA Smart Home app (iOS and Android). Select ERA Protect EP1.

2

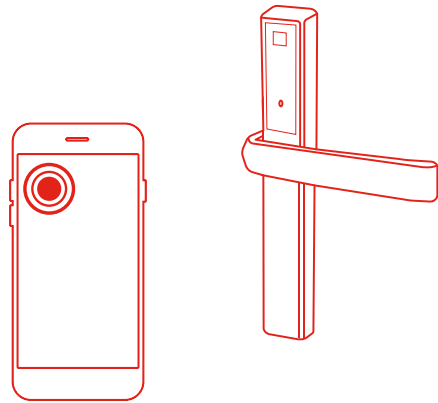

Ensure you are standing less than 2m from your handle and that Bluetooth is enabled on your mobile device.

3



Press the centre of the circle containing the "padlock" to unlock your EP1 Smart Universal door handle.

4

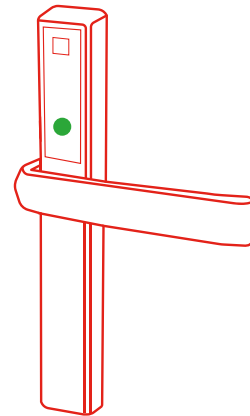

A GREEN LED light will display on the external handle. You will hear "door open" (if audio is enabled) and you can push the handle down to unlock.

Enable and disable Geolocation

1



Open the ERA Smart Home app (iOS and Android). Select ERA Protect EP1. Open settings and press "Geolocation Unlock".

2

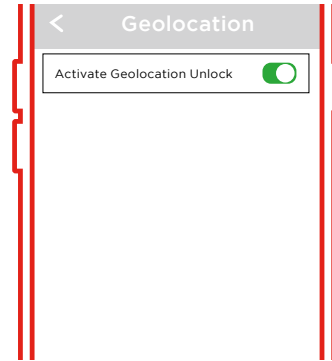

Press the "Activate Geolocation Unlock" slider to turn on Geolocation Unlock.

3



A pop up screen will notify you that Geolocation is now enabled, press "Ok" to confirm.

4



To turn off Geolocation, repeat steps 1 and 2, but turn the slider to the "off" position. Again a pop up message with display to confirm. .

Automatically unlocking your Handle with Geolocation via Bluetooth

- 1 Open the ERA Smart Home App (iOS or Android) and select ERA Protect EP1.
- 2 Open settings and choose the "Geolocation Unlock Control" option from the menu. When activating Geolocation, stand close to the door for precise recording of location coordinates.
- 3 When you activate this feature, it allows you to automatically unlock your door when you return home from beyond the 200 metre distance range. The handle will then only physically open when you are 5-10 metres from your Smart Universal Door Handle.
- 4 The feature is based on the location of your registered smartphone, which will require permission to use your phone location in the app settings. Please ensure that you change location access in your ERA Smart Home App to "Always" (without this setting, geolocation will not function).
- 5 You must leave your app running in the background on your phone for geolocation to initiate. If you close the app you will get a notification (iOS only) that services to the handle have stopped and request that you reopen the app to restart services to the handle.
- 6 You must move outside the 200 metre range from your handle to initiate the feature.
- 7 When you return inside the 200 metre range, the handle will prepare itself for your arrival, but will not unlock until your phone is 5-10 metres from the Smart Universal Door Handle. This is for security reasons.
- 8 As you walk up to your door, your handle will fully unlock once you are 5-10 metres away*. You can gain access to your property by pushing the lever of the handle down.
- 9 If you do not push the lever down within 30 seconds of the handle being unlocked. The handle will relock itself for security reasons.

*time span can be adjusted within the App.

Unlocking your handle via the thumbturn

1

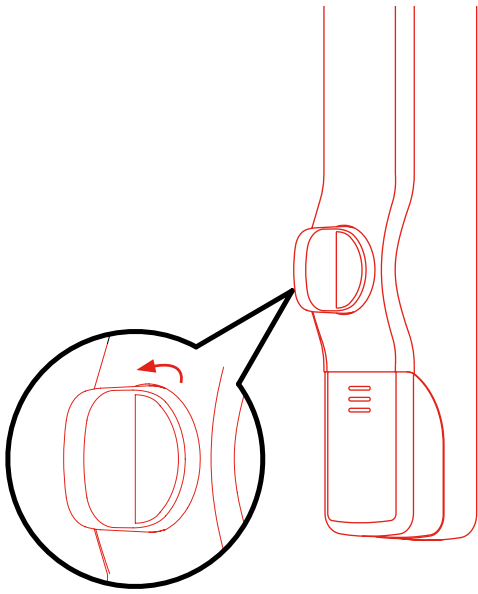

From inside the property, to unlock the door, please turn the thumbturn on the internal handle towards the door hinges.

2

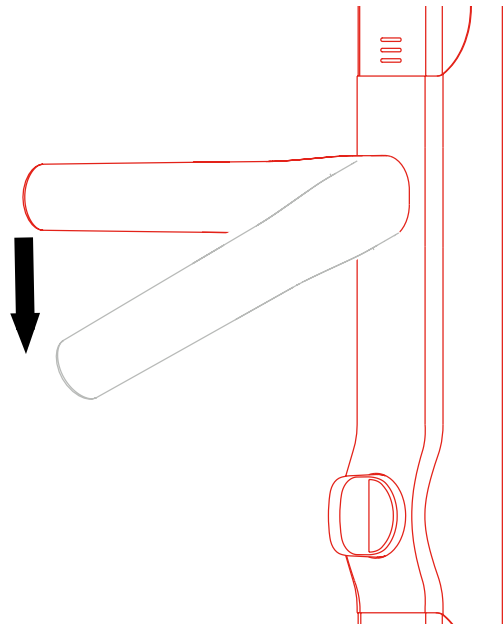

Then, push the lever of the handle down to unlock your door.

Deadlocking and auto locking your handle

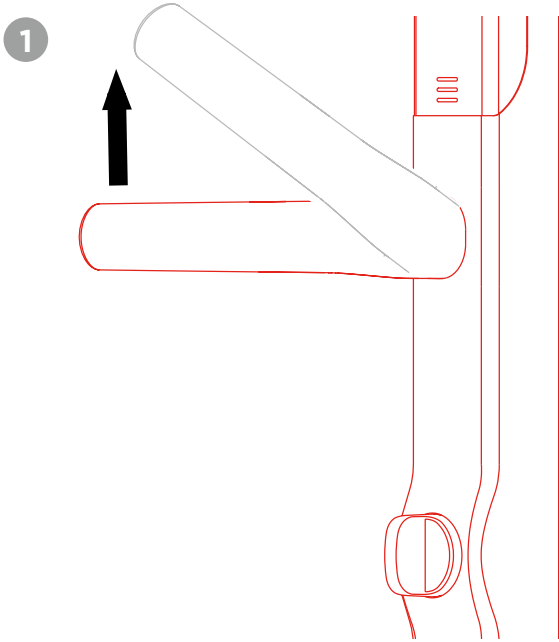

After entering or exiting the property, close the door and lift the lever handle upwards, this will automatically lock the door.

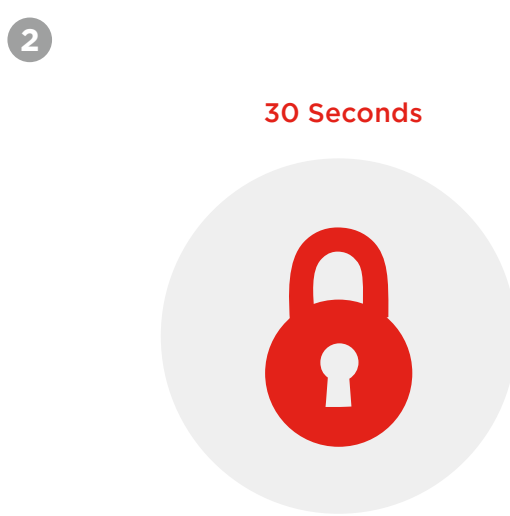

Auto lock: once unlocked with the app, fingerprint or key card the handle needs to be pushed downwards to open the door. If this is not done within 30 seconds, the handle will automatically re-lock the door (for security reasons) and you will need to unlock again.

Creating administrator, guest and family (10 accounts maximum)

- 1 Open the ERA Smart Home app.
- 2 Open "Account Settings".
- 3 In the "User Detail" section, select "Guest User" (you will see any guests already set up in case you wish to edit),
- 4 Click on the "+" and select the type of account you wish to add.
- 5 Select the type of user you wish to create - guest or family. Complete their details including their email address and phone number.
- 6 In the share section at the bottom, you can choose the functions you wish to share by selecting / deselecting the options.
- 7 Once you have set up any specified dates / times/ access levels etc (see table below). Click "Save". and you will then receive a notification that the Guest Invitation has been sent.
- 8 The Guest user you have created will be added to the Guest User List in your app.

When choosing ERA Protect you can define access level and e-key type by user

Anytime key	One-off key	Scheduled key	Timeout key	No access
Unlimited access until you revoke.	Allows one-off access and is valid for 1 hour.	Allows access for a specified time and date.	Allows immediate access until a specified time.	Revokes any access for a user.

Logging in as a guest / family user and changing passwords

1



All guests and family users must download the ERA Smart Home App (iOS and Android) if they require to use the app to unlock the door handle. For key card and fingerprint access, the main admin users can set up guests users within their app.

2

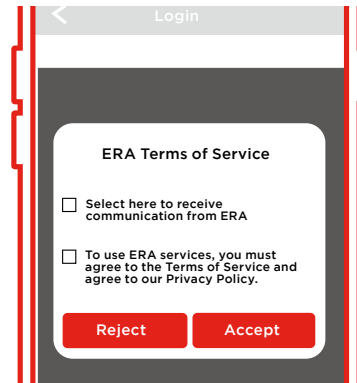

Open the app on your mobile device and create an account by completing required details. To use the app you must agree to ERA's Terms of Service and Privacy Policy.

3

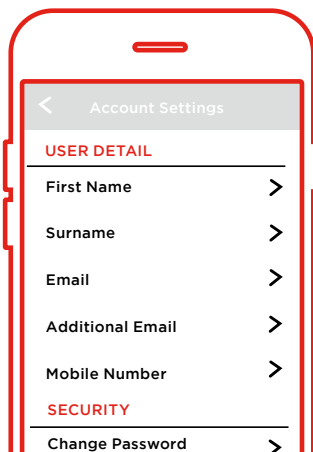

To change your password, open "Account Settings".

4

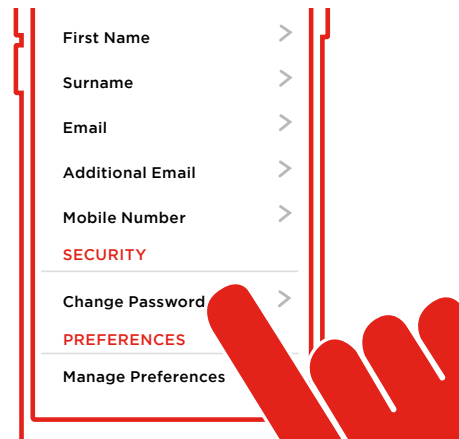

In the "Security" section, select "Change Password".

5

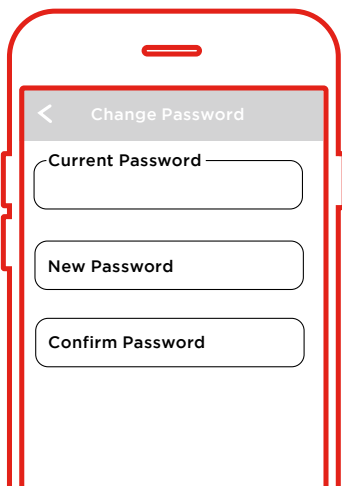

Enter the current password sent to you by email (the system sends an email once the administrator created you as a Guest User). Then enter a new password, confirm this password and then click "Save".

Once set up you will then have permission as granted by the administrator (Admin user).

Account access and user permissions

When adding smart devices into the ERA Smart Home app, a 'Smart Home' must be created; different levels of access to different members will be generated.

Permissions	Admin user (main user)	Family User	Guest User
Create an account	✓		
Add products	✓		
Access products - dashboard only for cameras, video doorbell, alarm	✓	✓ with permissions	✓ with permissions
View cameras and video doorbell	✓	✓ with permissions	✓ with permissions
Arm and disarm the alarm	✓	✓ with permissions	✓ with permissions
Change settings for all registered products	✓		
Add guests / family users	✓		
Access the ERA Protect EP1 dashboard	✓		
Add or delete any fingerprints	✓	✓	✓ with permissions
Delete the account	✓	✓ with permissions	

Enabling and disabling audio

1



Open settings of the ERA Protect EP1 handle.

2

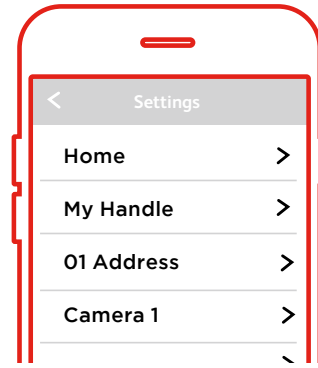

Press "My Handle".

3

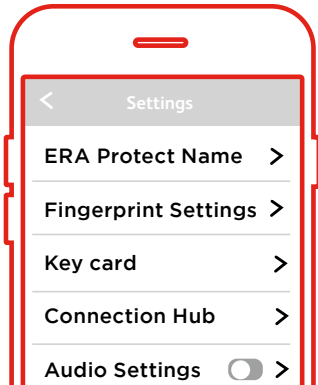

Using the slider next to "Audio Settings" you can turn on and off. Audio is turned "on" by default. A pop box will confirm audio is disabled.

4

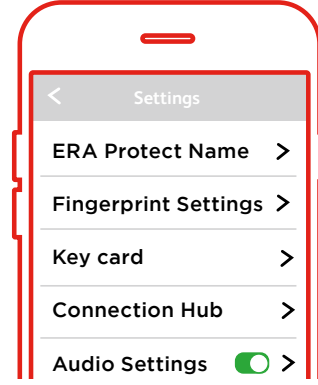

To turn on Audio, repeat the steps and slide the button to the right. A pop up box will confirm audio is now enabled.

Renaming your handle

1

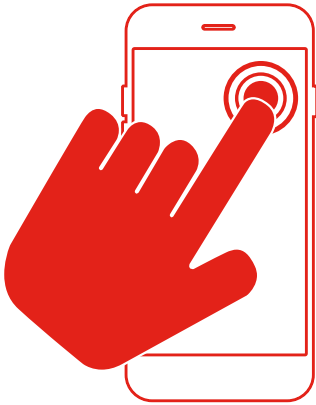

Open up the settings of the ERA Protect handle.

2

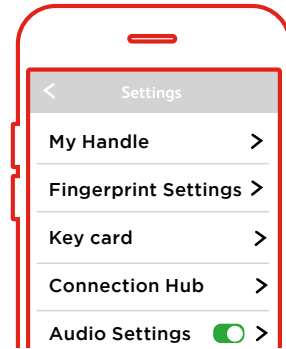

Press "My Handle" (or if you have renamed previously, the pre-selected name) and rename your device. Press "Save" once complete.

Back Up Power

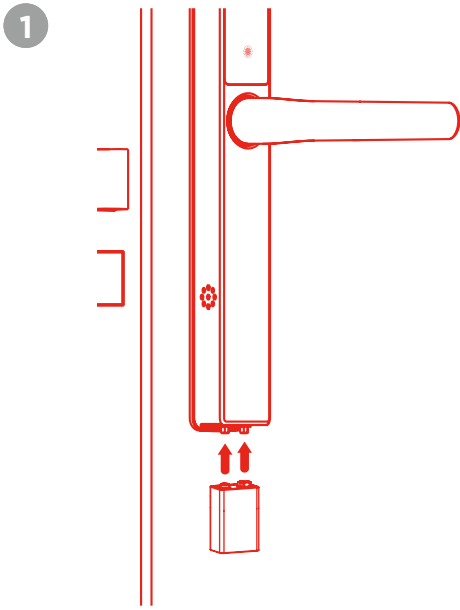

A 9V alkaline battery can be used to provide back up power to your EP1 door handle in case the installed batteries run out of power.

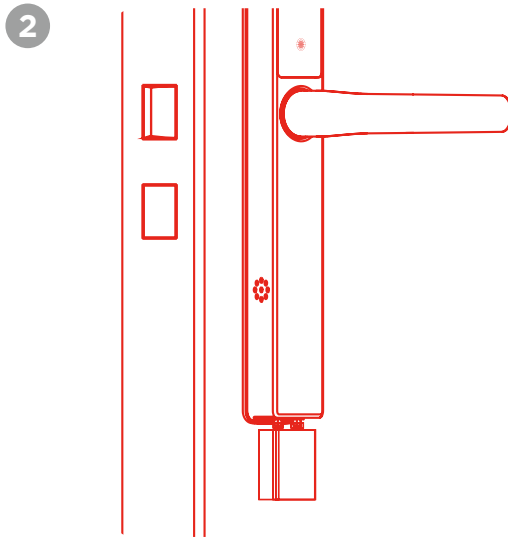

Connect a 9V alkaline battery to the back up power portal located underneath the external handle. While the 9V alkaline battery is connected, use the fingerprint scanner, app, or a key card to unlock your handle. Once the door is unlocked, it is important to replace the batteries (in the internal handle as soon as possible.)

Please make sure you use a 9V alkaline battery not a 9V zinc carbon battery.

Deleting your handle

1

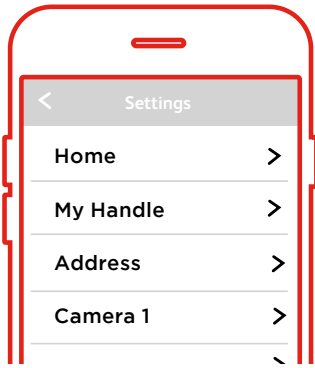

Open settings in the ERA Protect EP1 Handle and press the "dustbin" icon next to "My Handle".

2

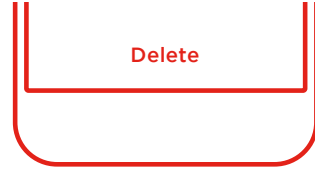

Read the information on the pop up notification and select "Delete" to remove your handle. Your handle is now deleted. You should now factory reset the handle (page 27).

How to factory reset your handle

- 1 Remove the "Set" cover near the base of the external handle.
- 2 Press the hard reset button for at least 15 seconds.
- 3 You will hear two voice prompts, hold the hard reset button until you hear the second voice prompt.
- 4 Wake up the handle up by touching the LED Wake Up button.
- 5 Push the handle down. If the handle does not go down turn the thumbturn to the open position, this will allow the handle to go down
- 6 Push the handle up
- 7 You will hear the motor engage and your handle has now been reset.

Decommissioning your device

- 1 Open the ERA Smart Home app.
- 2 Select ERA Protect EP1.
- 3 Select "Settings" (accessed by the menu or the settings icon on the ERA Protect EP1 dashboard in the top right hand corner, once the ERA Protect EP1 handle is connected).
- 4 To decommission the handle please delete all fingerprints (you need to be within 2m of the handle to perform this action").
 - 5 How to delete saved fingerprints:
 - Go to fingerprint settings in the ERA Protect EP1 settings page.
 - Press on the fingerprint you wish to delete
 - You will see Delete / Edit.
 - Press "Delete".
 - The fingerprint you selected will now be deleted. Please do this for all fingerprint.
 - 6 Go to the bottom of the ERA Protect EP1 Settings page:
 - You'll now see the "Delete ERA Protect EP1" icon.
 - Click "Delete ERA Protect EP1"
- 7 Please "Factory Reset" your ERA Protect EP1 lock to restore the lock to the factory settings. See page 27.

Deleting an ERA account

- 1 Ensure that all devices associated with your account have been deleted.
- 2 Send an email to customer support at info@erahomesecurity.com from the primary email address associated with your account informing them you wish to delete your account.
- 3 ERA will respond to your request within 14 days. This may be extended further if additional information is required.
- 4 ERA will confirm by email that the account has been deleted.

Understanding your Smart Universal Door Handle

LED Colour	Definition
Single RED light for 2 - 3 seconds	EP1 booting up or powering on
Single RED light for 2 - 3 seconds	EP1 has been reset
Flashing BLUE light	EP1 is in initial Bluetooth pairing mode
Single GREEN light for 2 - 3 seconds	Successful opening by Bluetooth or fingerprint
Single RED LED flashing for 2 minutes	Fingerprint not validated for opening
Continuous RED LED flashing for 2 minutes	Door lock has been tampered with
Continuous RED LED flashing for 2 minutes	If after the delay the sensor is giving the signal that the door is still open (wrong status or open when it is supposed to be closed)
Continuous RED LED flashing for the duration of the Firmware upgrade process.	Firmware upgrade in progress

Warranty information

Our Promise

We at ERA firmly believe in the quality of our goods. Our technology achieves outstanding performance and durability and we can therefore offer, in addition to your statutory rights, an additional limited guarantee.

Smart Security: a 2 year guarantee commencing on completion of installation.

Critical Security and Firmware Updates: for 4 years from the major version date of the software within the ERA Protect.

If a material defect occurs in the hardware or smart security before the end of the relevant guarantee period set out above, ERA will (in its sole discretion) replace the hardware or security (or the defective part there of) free of charge.

ERA may, as part of any replacement of hardware or smart security, supply alternative hardware or smart security that it considers to be of similar or better quality where the particular hardware or smart security subject to the defect are obsolete or otherwise unavailable.

The ERA Protect Guarantee is only valid when the following terms and conditions are met in full:

This limited guarantee is not transferable and is extended only to, and is solely to the benefit of, the original purchaser of the product. Please retain your dated sales invoice as proof of purchase and forward this to us if you wish to make a claim under this guarantee.

Products must be installed, used and maintained in accordance with our instructions otherwise the guarantee will be invalidated.

The product must not be damaged or modified in any way nor must it have been subjected to any unauthorised repairs.

Exclusions

To read the guarantee terms and conditions, including exclusions in full, please visit eraprotect.com. The ERA Protect Guarantee is in addition to your legal rights. It does not exclude, restrict or modify your legal rights, including under consumer law in the UK.

To make a claim

You must first notify your installer using the details they will have provided you. If your installer is not providing you with the assistance you require, you can phone us at 0345 646 1487 (during office hours) and we will then provide you with assistance in making your claim under the ERA Protect Guarantee.

*Terms and conditions apply.

Recycling and disposal

Disposal of this product is covered by the Waste Electrical or Electronic Equipment (WEEE) Directive. It should not be disposed of with other household or commercial waste. At the end of the product's useful life, the packaging and product should be disposed of via a suitable recycling centre.

EC Declaration of Conformity

ERA hereby declare that this equipment complies with the essential requirements of the Radio and Telecommunications Terminal Equipment Directive 2014/53/EU. A copy of the EU Declaration of Conformity is available at www.eraprotect.com.

All rights reserved. All trade names are registered trademarks of respective manufacturers listed. App Store is a service mark of Apple Inc. Android and the "Google Play" logo are trademarks of Google Inc. Phone not included.

Data Protection

ERA is committed to processing your personal data in compliance with all applicable data protection laws. For more information regarding how we process your personal data, please see our privacy policy at eratouchkey.com or it is available from us on request.

Privacy policy

What we collect about you

We collect the following personal and device information when visiting our sites or using our products:

Personal & Account Information:

Information required and collected during device setup is your name, email address, password and mobile telephone number.

Fingerprint	Physical	Enabled for setup and daily operation	ERA Universal Smart Handle
RFID	AIR	Enabled for setup and daily operation	ERA Universal Smart Handle
9V Battery Terminal	Physical	Enabled if low battery power or no power	ERA Universal Smart Handle
Bluetooth	AIR	Enabled to interact with handle on daily basis	ERA Universal Smart Handle
WLAN	Network	Enabled to interact with handle with Wi-Fi module is added	ERA Universal Smart Handle

While using your device(s) we will collate:

- When the ERA Smart Home app is used to unlock your handle.
- When a recognised fingerprint is used to unlock your handle.
- When you use the RFID KeyCard to unlock your handle.
- When you use the remote unlock facility.

An event log is kept for your review, and is accessible via the ERA Smart Home app. If you are invited to create an additional user account, we will collect your name and email address. Other account details will be obtained directly from you during the setup process.

Device Information:

Device Information, such as model and MAC number, physical network information (including IP address), device activity logs, and historic and current device configuration.

Clear User Data ERA Smart Universal Handle

Please note that this will remove all fingerprint and key card data from your handle, so you will only be able to open your handle using the ERA Smart Home app. To use fingerprints or keycards to open your handle, you will need to readd them using the ERA Smart Home app. Make sure your door is unlocked and remove the Setting Cover from the internal handle. Press the hard reset button, and then release once you hear the first voice prompt. Wake up the handle, by touching the LED wake up button, and then follow the voice prompts on the handle to complete the clear user data process.

Factory Reset ERA Smart Universal Handle

Please note that this will remove all data from the handle and place it in installation matter. This will leave the door unsecure, until the handle is added to an account. Make sure your door is unlocked and remove the Setting Cover from the internal handle. Press the hard reset button, and then release once you hear the second voice prompt. Wake up the handle, by touching the LED wake up button, and then follow the voice prompts on the handle to complete the clear user data process.

Deleting Fingerprint users from the handle

To delete fingerprint users from the handle, you need to do the following:

1. Open the ERA Smart Home app.
2. Connect to your handle.
3. Go to handle settings.
4. Select Fingerprint Settings
5. Press the three dots next the fingerprint you wish to delete.
6. Select Delete Fingerprint.



Things to remember

- 1 Please ensure that you read the manual fully before attempting installation of the handle.
- 2 **Please ensure you hold the door open in the unlocked position while installing the handle to prevent getting locked in or out of the property. It is also imperative that the handle is installed with the multi-point door lock in the unlocked condition, otherwise the handle will not sequence correctly during installation.**
- 3 Please ensure you correctly install, set up and test the handle before leaving the property.
- 4 If you experience any problems with your installation, or if you need any help setting up or operating the ERA Protect handle, please contact our customer helpline.
- 5 In the unlikely event you should be locked out of your property, we would advise speaking to a local locksmith.

Please visit eraprotect.com to access the latest FAQs, videos and downloads:

ERA Home Security Ltd

Valiant Way, Wolverhampton,
West Midlands, WV9 5GB

Customer Helpline: **0345 646 1487**
eraprotect.com