

ERA

KNOB LOCKSET Fitting Instructions

Entrance, Privacy and Passage locksets. For use on doors 35mm to 45mm thick.

KIT CONTENTS

1. Door Knobs

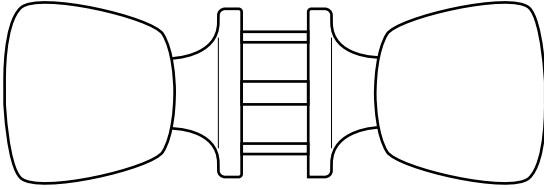

2. Latch

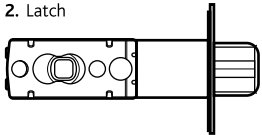

3. Keep

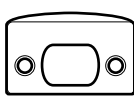

4. Dust Pocket

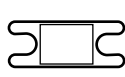

5. Keys

Entrance - 2
Privacy - 1
Passage - 0



6. Screws x4

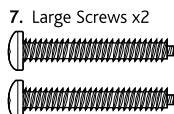

7. Large Screws x2

To fit the Door set you will require the following tools:

- Power Drill
- 54mm holesaw
- 25mm drill bit
- Chisel
- Posidriv Screwdriver
- Pencil
- Hammer

1. PREPARE DOOR

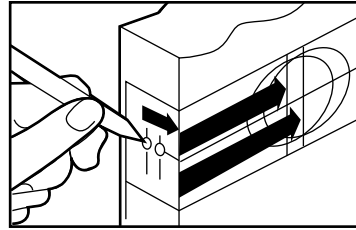

Fold and position template at the desired height for the lockset. Mark latch hole position as shown.

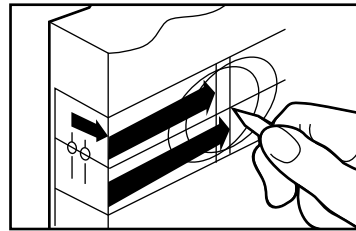

Mark the centre point of the lockset hole on the door face at the desired backset, either 60mm or 70mm.

2. DRILL HOLES

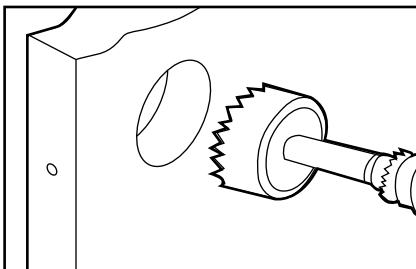

Using a 54mm hole saw, drill through the face of door. It is recommended that holes be drilled from both sides to prevent splitting.

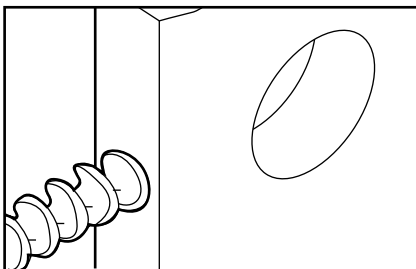

Drill a 25mm hole in the centre of the door edge through to the 54mm hole.

3. PREPARE LATCH

To extend latch to 70mm backset, slide spindle hub in the direction shown.

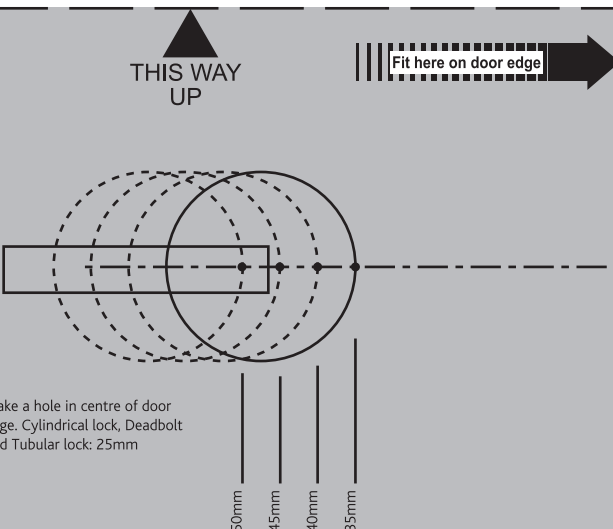
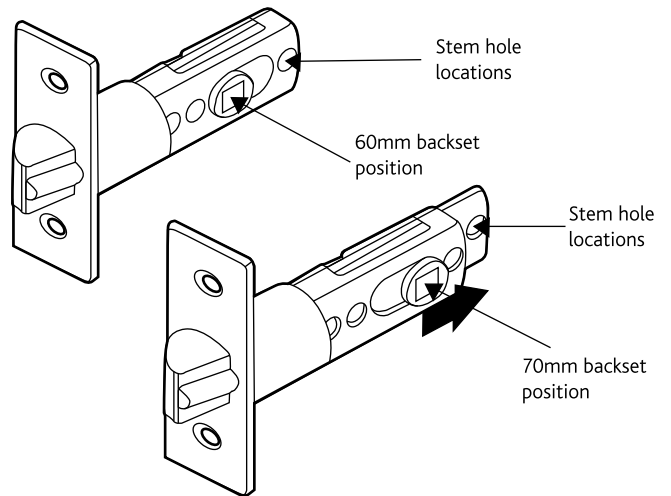

PAPER MARKER

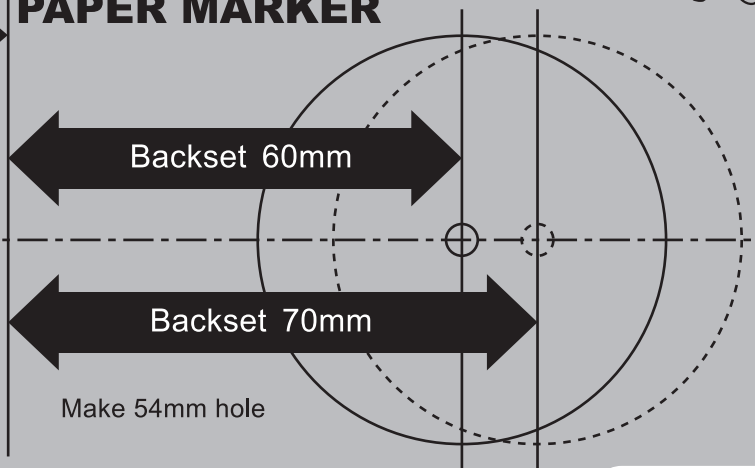

● **TEMPLATE**

4. INSTALL LATCH

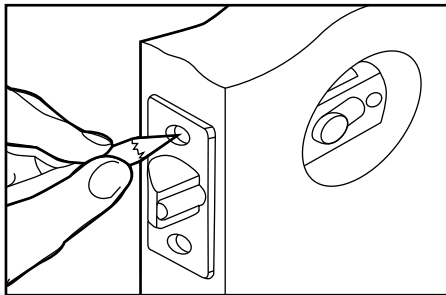

1. Insert latch in hole. Keeping it parallel to door face, mark outline of latch face and screw holes. Remove the latch.

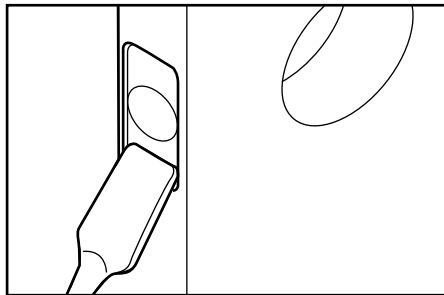

2. Chisel a 3mm deep rebate or until the latch face is flush with the door edge.

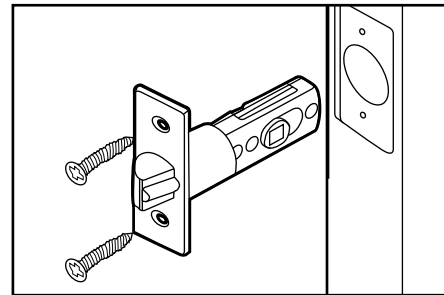

3. Insert the latch and tighten the screws.

5. INSTALL STRIKE

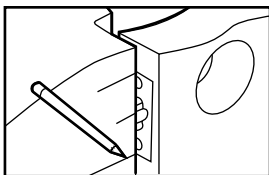

With the latch inserted into the door, close the door and mark the position of the strike on the door jamb and centre position of the latch.

Bore a 25mm hole to a depth of 25mm at the centre position of the latch.

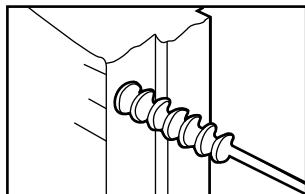

Position strike on door jamb at the positions marked, scribe around the strike and chisel out the rebate to a depth of 2mm.

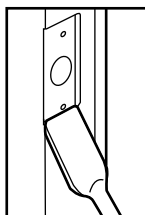
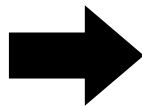
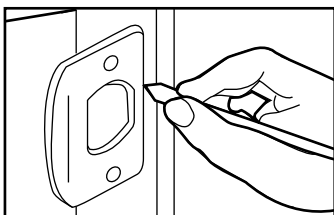

Secure strike to door with two wood screws provided. To prevent loose fit of the latch and the strike, bend small tab in the strike.

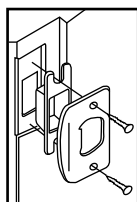
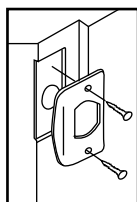

6. INSTALL EXTERIOR MECHANISM

Insert exterior knob and rose by placing on spindle and aligning screw holes with stems. Push flush against the door and insert two long screws and tighten.

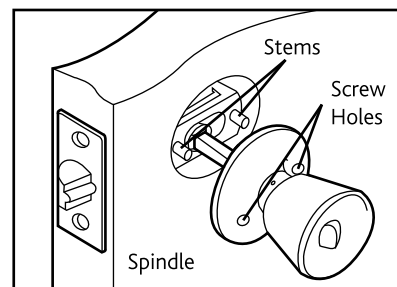
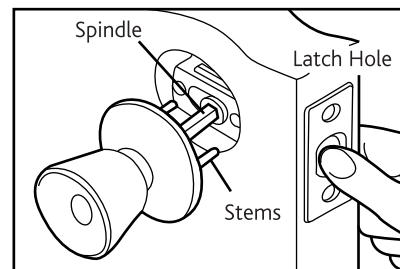

Insert exterior knob with spindle into latch making certain that the stems are positioned correctly through the latch holes. Press flush against the door. Ensure the key section is in the correct position.

ERA

For more info call
01922 490000 or visit
www.erahomesecurity.com

TECHNICAL HELPLINE
01922 490 050

ERA Home Security, Valiant Way, Wolverhampton, WV9 5GB